

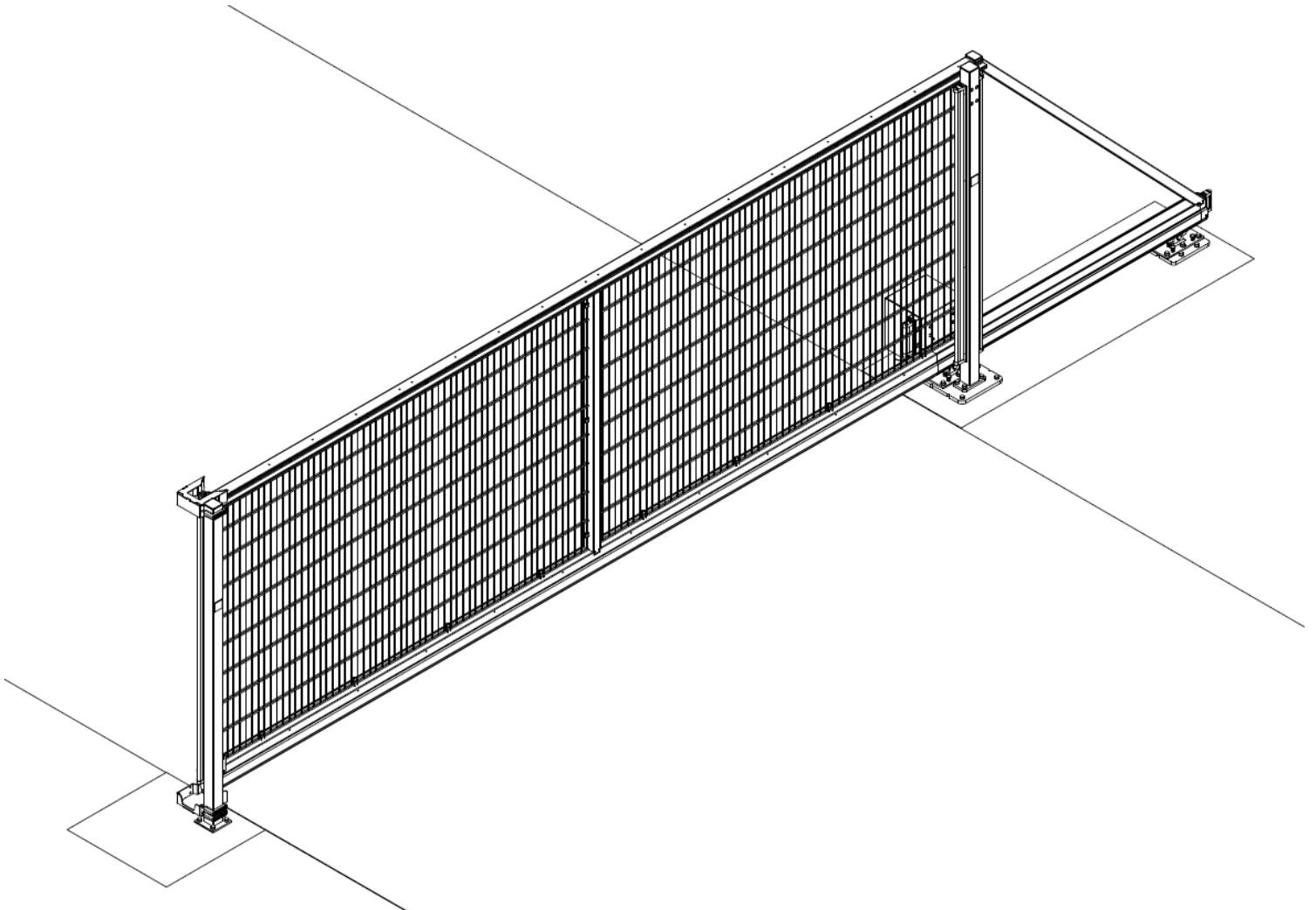

[Installatiehandleiding NL](#)  
[Installation manual EN](#)  
[Installations-Handbuch DE](#)  
[Manual d'installation FR](#)  
[Installationsanvisningar SV](#)  
[Monteringsvejledning DA](#)  
[Installasjonsveiledning NO](#)

# Condor



## Disclaimer

Neem deze handleiding voor installatie volledig door. Alle beschreven werkzaamheden moeten worden uitgevoerd door gecertificeerd personeel. Als er afgeweken wordt van de beschreven handelingen vervalt elke vorm van garantie en aansprakelijkheid van de fabrikant.

## Veiligheid

Draag altijd de juiste beschermde kleding bij het uitvoeren van de werkzaamheden.

Gebruik altijd een ti hulp/hijsinstallatie bij het verplaatsen van zware en/of grote objecten.

Gebruik altijd passend gereedschap.

Het toevoegen of weglaten van onderdelen, anders dan beschreven in deze handleiding, kan nadelige gevolgen hebben op het functioneren en dus de veilige werking van het uiteindelijke product en wordt dan ook ten strengste afgeraden.



**GEVAAR!** Laat werkzaamheden aan elektrische onderdelen door gecertificeerd personeel uitvoeren.

## Verwijdering en demontage

Voer het product af volgens de lokale wet- en regelgeving.

Voor gebruik en onderhoud zie de gebruikershandleiding en/of servicehandleiding.

## Maatvoering

Alle maten en afmetingen zijn in mm tenzij anders vermeld.

## Contact

Zie achterzijde van deze handleiding.

## Uitleg symbolen



Gebruik een steeksleutel.  
Het cijfer geeft de steekmaat in mm aan.

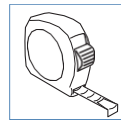

Controleer de afstand.

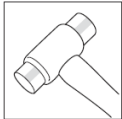

Gebruik een hamer.

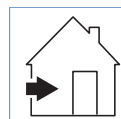

Binnenterrein.

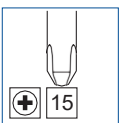

Gebruik een schroevendraaier.  
Het symbool geeft het type schroef aan. Het cijfer geeft de afmeting van de schroef aan.

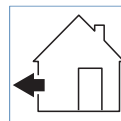

Buitenterrein.

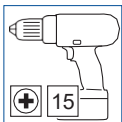

Gebruik een schroefmachine.  
Het symbool geeft het type schroef aan. Het cijfer geeft de afmeting van de schroef aan.



Een kuil graven.



Gebruik een boor.  
Het cijfer geeft de boordiameter in mm aan.



Gebruik beton  
Volg de instructies op de verpakking

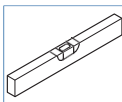

Zorg ervoor dat de aangegeven onderdelen waterpas zijn.

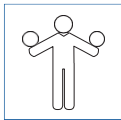

Deze stap is optioneel.



Gebruik een borstel.



Bekijk een andere handleiding.

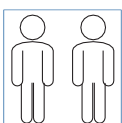

Voer de werkzaamheden niet alleen uit.



Pagina referentie  
Geeft een verwijzing naar een pagina aan.

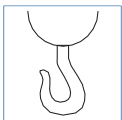

Gebruik een tilhulp/  
hijsinstallatie.



Gebruik een pomp.



Gebruik IP4 bit.



## Disclaimer

Read the full manual before installation. All described work must be performed by trained personnel. Should you deviate from the instructions, any warranty entitlement and liability of the manufacturer shall no longer apply.

## Safety

Always wear the correct protective clothing when performing the work.

Always use a lifting tool/hoisting system when moving heavy and/or large objects.

Always use suitable tools.

Adding or removing parts other than as described in this manual can have negative consequences on the operation and, therefore, the safe operation of the final product and we categorically advise against this.



**DANGER!** Work on electrical components must be performed by certified personnel.

## Removing and disassembling

Dispose of the product in accordance with local legislation and regulations.

For use and maintenance see the user manual and/or service manual.

## Dimensions

All sizes and dimensions are in mm unless stated otherwise.

## Contact

See the back of this manual.

## Explanation of symbols



Use an open-end wrench.  
The number specifies the insertion size in mm.

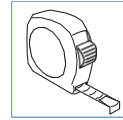

Check the distance.

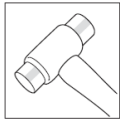

Use a hammer.

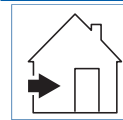

Indoors

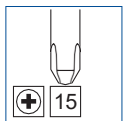

Use a screwdriver.  
The symbol specifies the type of screw. The number specifies the size of the screw.

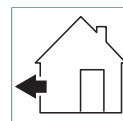

Outdoors.

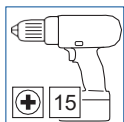

Use a electric screwdriver.  
The symbol specifies the type of screw. The number specifies the size of the screw.



Dig a hole.



Use a drill.  
The number specifies the drill bit diameter in mm.



Use concrete  
Follow the instructions on the packaging

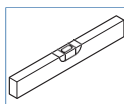

Ensure that the specified parts are level.

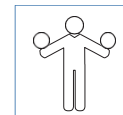

This step is optional.



Use a brush.



Refer to a different manual.

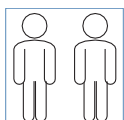

Do not perform the work on your own.



Page reference  
Specifies a reference to a page.

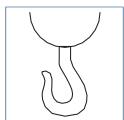

Use a lifting tool/hoisting system.

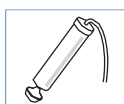

Use a pump.



Use IP4 bit.

## Haftungsausschluss

Lesen Sie vor der Installation die gesamte Anleitung. Alle beschriebenen Arbeiten müssen durch zertifiziertes Personal ausgeführt werden. Bei Abweichungen von den beschriebenen Handlungen erlischt jegliche Garantie oder Haftung des Herstellers.

## Sicherheit

Tragen Sie bei der Ausführung der Arbeiten immer angemessene Schutzkleidung.

Verwenden Sie zum Bewegen von schweren und/oder großen Gegenständen immer entsprechendes Hebezeug.

Verwenden Sie immer angemessenes Werkzeug.

Das Hinzufügen oder Entfernen von Teilen, abgesehen von den in dieser Anleitung beschriebenen Fällen, kann sich nachteilig auf die Funktion und damit auf den sicheren Betrieb des Endprodukts auswirken. Daher wird dringend davon abgeraten.



GEFAHR! Lassen Sie Arbeiten an elektrischen Teilen durch zertifiziertes Personal durchführen.

## Ausbau und Demontage

Entsorgen Sie das Produkt gemäß örtlichen Gesetzen und Richtlinien.

Zu Bedienung und Wartung siehe Bedienungs- und/oder Wartungsanleitung.

## Aufmaß

Alle Maße und Abmessungen in mm, sofern nicht anders angegeben.

## Kontakt

Siehe Rückseite dieser Anleitung.

## Symbolverzeichnis



Gabelschlüssel verwenden.  
Die Ziffer gibt die Schlüsselgröße  
in mm an.

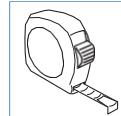

Distanz prüfen.

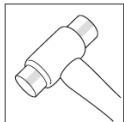

Benutzen Sie einen Hammer.

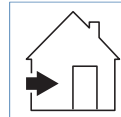

Innengelände.

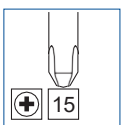

Schraubendreher verwenden.  
Das Symbol gibt die Art der  
Schraube an. Die Ziffer gibt die  
Abmessung der Schraube an.

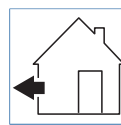

Außengelände.

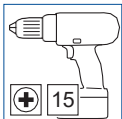

Elektrischen Schraubendreher  
verwenden. Das Symbol gibt die  
Art der Schraube an. Die Ziffer gibt  
die Abmessung der Schraube an.



Ein Loch graben.

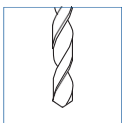

Bohrer verwenden.  
Die Ziffer gibt den  
Bohrerdurchmesser in mm an.

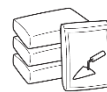

Beton verwenden  
Befolgen Sie die Anweisungen auf der  
Verpackung

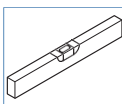

Sorgen Sie dafür, dass die  
angegebenen Teile waagrecht  
sind.

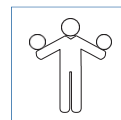

Dieser Schritt ist optional.



Verwenden Sie eine Bürste.



Siehe eine andere Anleitung.

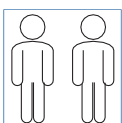

Die Arbeiten nicht allein  
ausführen.



Seitenreferenz  
Gibt einen Verweis auf eine  
Seite an.

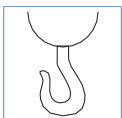

Ein Hebezeug verwenden.



Verwenden Sie eine Pumpe.



Verwenden Sie IP4-Bit.



## Déni de responsabilité

Lire entièrement ce manuel avant de procéder à l'installation. Tous les travaux décrits doivent être effectués par un personnel certifié. Tout écart par rapport aux instructions décrites entraînera l'annulation de toute forme de garantie et de responsabilité du fabricant.

## Sécurité

Porter toujours les vêtements de protection appropriés lors de l'exécution des travaux.

Utiliser toujours un accessoire de levage/ appareil de relevage pour déplacer des objets lourds et/ou volumineux.

Utiliser toujours un outillage adéquat.

L'addition ou la suppression de pièces autres que celles décrites dans ce manuel peuvent avoir des effets négatifs sur le fonctionnement et donc sur la sécurité de fonctionnement du produit fini. Elles sont donc vivement déconseillées.



**DANGER !** Confier les travaux visant les composants électriques à un personnel certifié.

## Enlèvement et démontage

Évacuer le produit conformément aux dispositions légales et réglementaires locales.

Pour l'utilisation et l'entretien, voir le manuel d'utilisation et/ou le manuel de maintenance.

## Cotes et dimensions

Sauf indication contraire, toutes les cotes et dimensions sont exprimées en mm.

## Contact

Voir au dos de ce manuel.





## Signification des symboles



Utiliser une clé plate.  
Le chiffre indique le calibre en mm.

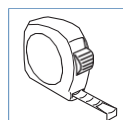

Vérifier la distance.

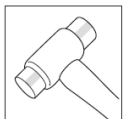

Utilisez un marteau.

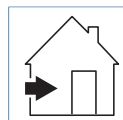

Intérieur.

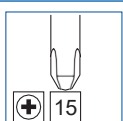

Utiliser un tournevis.  
Le symbole indique le type de vis. Le chiffre indique la dimension de la vis.

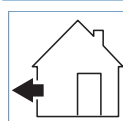

Extérieur.

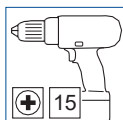

Utiliser un tournevis électriques.  
Le symbole indique le type de vis. Le chiffre indique la dimension de la vis.



Creuser un trou.

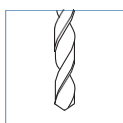

Utiliser une perceuse.  
Le chiffre indique le diamètre de perçage en mm.

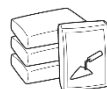

Utiliser du béton  
Suivez les instructions sur l'emballage

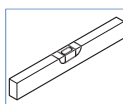

Veiller à ce que les parties indiqués soient de niveau.

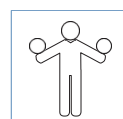

Cette étape est optionnelle.



Utilisez une brosse.



Consultez un autre manuel.

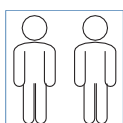

Ne pas exécuter les travaux seul.



Référence de page  
Indique un renvoi à une page.

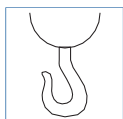

Utiliser un accessoire de levage/  
appareil de relevage.



Utilisez une pompe.



Utiliser le bit IP4.

## Ansvarsfriskrivning

Läs hela handboken innan installationen. Alla arbetsmomentsom beskrivs här måste utföras av utbildad personal. Om du inte följer instruktionerna då gäller varken garantin eller tillverkarens ansvar.

## Säkerhet

Använd alltid rätta skyddskläder vid arbete med utrustningen.

Använd alltid ett lyftverktyg eller en lyftanordning när du flyttar tunga eller stora föremål.

Använd alltid lämpliga verktyg.

Vi avråder bestämt från att lägga till eller ta bort delar, annat än vad som beskrivs i denna handbok, eftersom det kan få negativa följder för slutproduktens driftsäkerhet.



FARA! Arbete med elektriska komponenter måste utföras av behörig personal.

## Borttagning och isärtagning

Deponera produkten enligt lokala regler och föreskrifter.

För användning och underhåll se användarmanual eller servicehandboken.

## Mått

Alla storlekar och mått är i mm om inget annat anges.

## Kontaktuppgifter

Se baksidan av denna handbok.



## Symbolförklaring



Använd en fast nyckel.  
Numret anger storlek i mm.

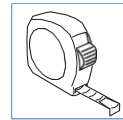

Kontrollera avståndet.

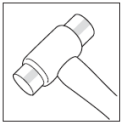

Använd en hammare.

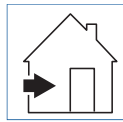

Inomhus

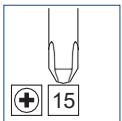

Använd en skruvmejsel.  
Symbolen indikerar typ av skruv.  
Numret anger skruvens storlek.

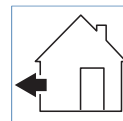

Utomhus.

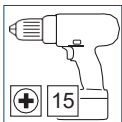

Använd en elektrisk skruvdragare.  
Symbolen indikerar typ av skruv.  
Numret anger skruvens storlek.



Gräva ett hål



Använd en bormaskin.  
Numret anger borrets diameter  
i mm.



Använd betong  
Följ instruktionerna på  
förpackningen

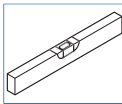

Se till att de angivna delar är i  
jämnhöjd.



Detta steg är frivilligt.



Använd en borste.



Se en annan handbok.

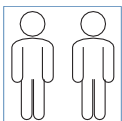

Utför inte arbetet på egen hand.



Sidhänvisning  
Anger en referens till en sida.

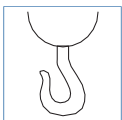

Använd ett lyftverktyg eller en  
lyftanordning.



Använd en pump.



Använd IP4 bit.

## Monteringsvejledning

### Ansvarsfraskrivelse

Læs hele vejledningen før montering. Alt arbejde skal udføres af specialuddannet personale. Hvis du ikke følger vejledningerne, frafalder enhver ret til garanti og producenten kan ikke længere holdes til ansvar.

### Sikkerhed

Brug altid beskyttelsestøj når der arbejdes.

Brug altid løfteværktøj/hejsesystem når der flyttes tunge og/eller store genstande.

Brug altid passende værktøj. Tilføjelse eller fjernelse af andre dele, end dem beskrevet i denne vejledning kan påvirke funktionen negativt og hermed det endelige produkts sikre drift og vi fraråder dette kategorisk.



FARE! Arbejde på elektriske komponenter må kun udføres af autoriseret personale.

### Fjernelse og afmontering

Bortskaf produktet i overensstemmelse med lokal lovgivning og bestemmelser.

For brug og vedligeholdelse, se brugervejledningen og/eller servicevejledningen.

### Mål

Alle størrelser og mål er i mm, med mindre andet angives.

### Kontakt

Se bagsiden på denne vejledning.



## Forklaring af symboler



Brug en skiftenøgle Nummeret angiver den størrelse der skal bruges i mm.

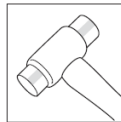

Brug en hammer.

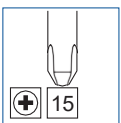

Brug en skruetrækker Symbolet angiver skruetypen. Nummeret angiver skruens størrelse.

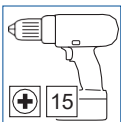

Brug en elektrisk skruetrækker Symbolet angiver skruetypen. Nummeret angiver skruens størrelse.

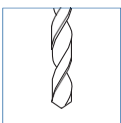

Brug en boremaskine Nummeret angiver den diameter bor der skal bruges i mm.

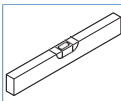

Kontroller at de angivne niveauer er vandret.

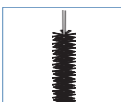

Brug en børste.

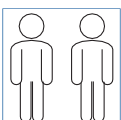

Udfør ikke selv arbejdet.

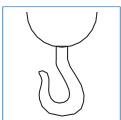

Brug løfteværktøj/hejsesystem.



Brug en pumpe.



Brug IP4 bit.

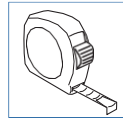

Kontroller afstanden.

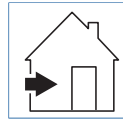

Indendørs.

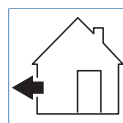

Udendørs.



Grave et hul.



Brug beton  
Følg instruktionerne på

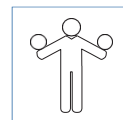

Dette trin er valgfrit.



Se en anden manual.



Sidehenvisning  
Angiver en reference til en



## Ansvarsfraskrivelse

Les hele bruksanvisningen før installasjon. Alt beskrevet arbeid må utføres av opplært personell. Hvis du skulle avvike fra instruksjonene vil ikke lenger eventuelle garantier eller produsentens ansvar gjelde.

## Sikkerhet

Husk å alltid bruke passende verneklær mens arbeidet utføres.

Bruk alltid løfteredskaper/heisesystemer når du flytter tunge og/eller store gjenstander.

Bruk alltid passende verktøy.

Ikke legg til eller fjern deler annet enn det som er beskrevet i denne bruksanvisningen. Dette for å unngå negative konsekvenser for sikker betjening av det ferdige produktet.



FARE! Arbeid på elektriske komponenter må utføres av sertifisert personell.

## Fjerning og demontering

Kast produktet i henhold til lokale lover og forskrifter.

For bruk og vedlikehold, se bruksanvisningen og/eller servicehåndboken.

## Dimensjoner

Alle størrelser og dimensjoner er i mm, om ikke annet er oppgitt.

## Kontakt

Se denne bruksanvisningens bakside.

**Forklaring av symboler**

Bruk en fastnøkkel  
Tallet spesifiserer  
innføringsstørrelsen i  
mm.

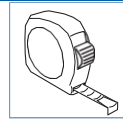

Kontroller avstanden

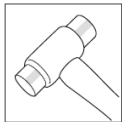

Bruk en hammer.

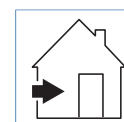

Innendørs.

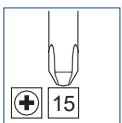

Bruk et skrujern  
Symbolet angir skruetypen.  
Tallet spesifiserer  
skruestørrelsen.

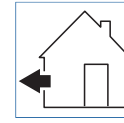

Utendørs.

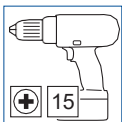

Bruk en elektrisk skrutrekker  
Symbolet angir skruetypen.  
Tallet spesifiserer  
skruestørrelsen.



Grav et hull.

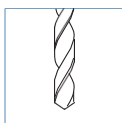

Bruk en drill  
Tallet spesifiserer diameteren til  
drillbitsen i mm.



Bruk betong  
Følg instruksjonene på  
emballasjen

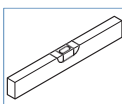

Forsikre deg om at de  
spesifiserte delene er i vater.

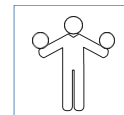

Dette trinnet er valgfritt.



Bruk en børste.



Dette trinnet er valgfritt.

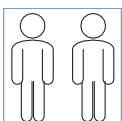

Ikke utfør arbeidet på  
egenhånd.



Sidereferanse  
Angir en referanse til en  
side.

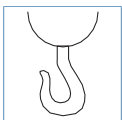

Bruk et løfteredskap/  
heisesystem.



Bruk en pumpe.



Bruk IP4 bit.

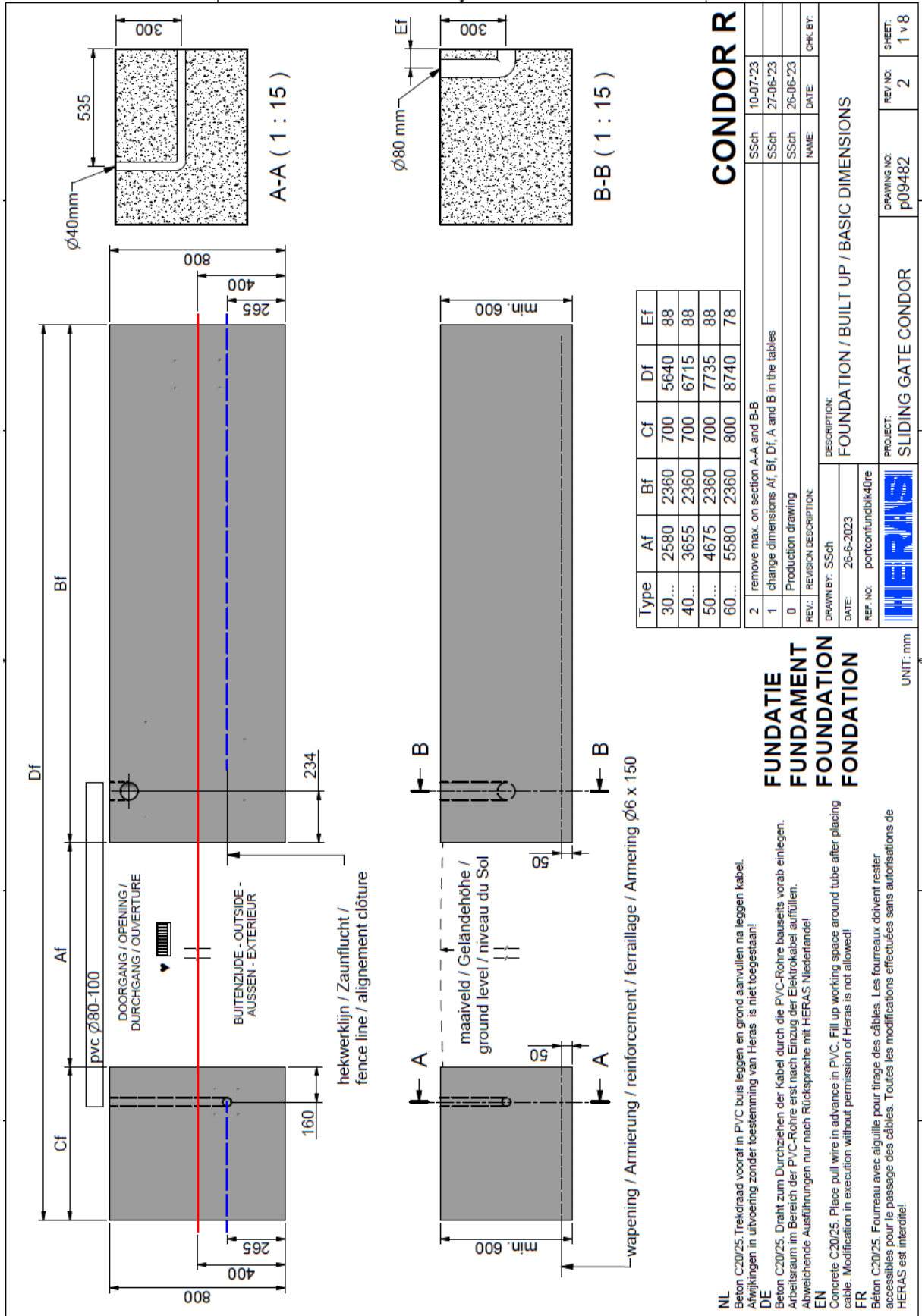



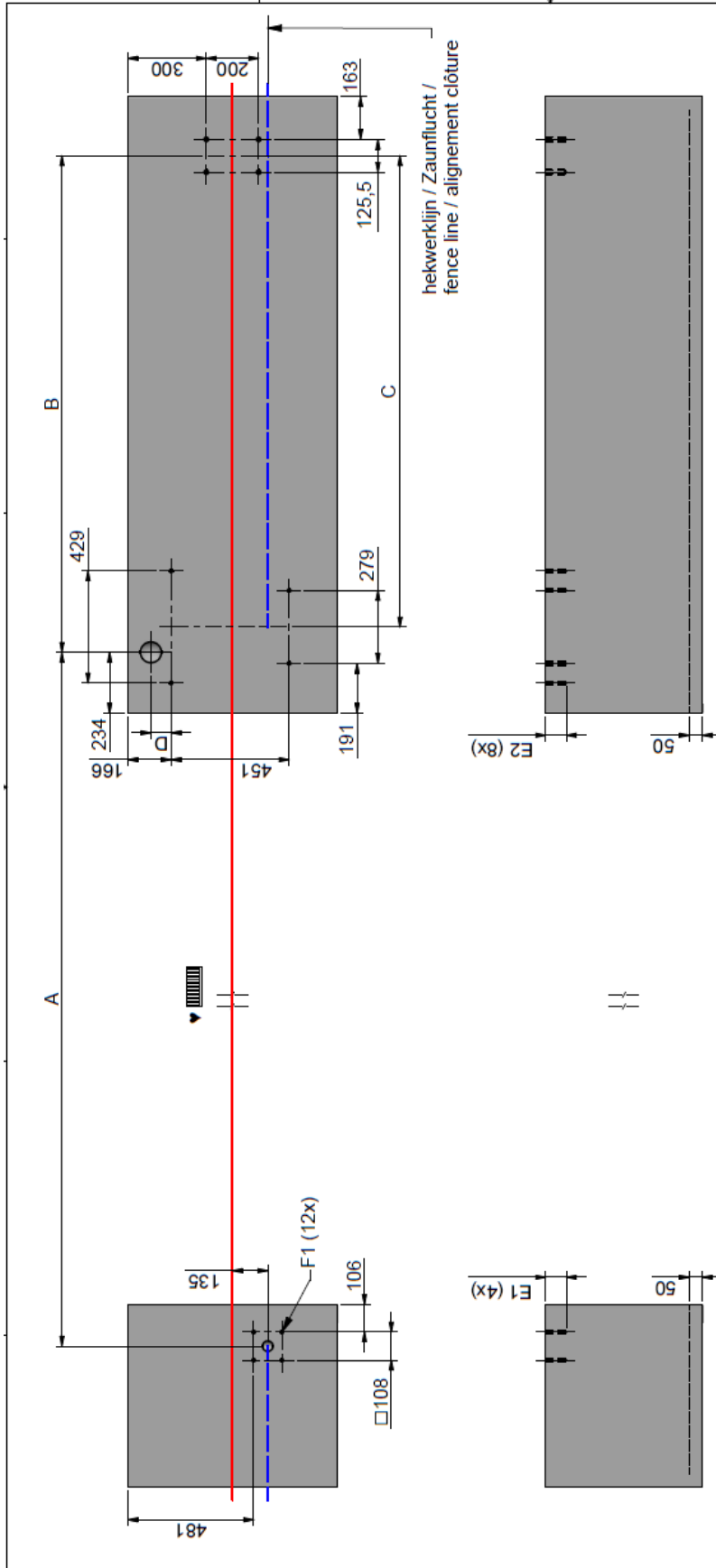

## CONDOR R

Type	A	B	C	D	thread x length	E1	E2	F1	torque
30...	2973	1900	1803	77,5	M12x110 mm	90 mm	80 mm	12 mm	60 Nm
40...	4048	1900	1803	77,5					
50...	5068	1900	1803	77,5					
60...	5973	1900	1803	87,5					

DESCRIPTION		SSch	DATE	CHK. BY:
2	remove max. on section A-A and B-B	SSch	10-07-'23	
1	change dimensions Af, Bf, Df, A and B in the tables	SSch	27-06-'23	
0	Production drawing	SSch	26-06-'23	

DRAWN BY:	DATE:	DESCRIPTION:	REF. NO.:	PROJECT:	DRAWING NO.:	REV. NO.:	SHEET:
SSch	26-6-2023	FOUNDATION / BUILT UP / BASIC DIMENSIONS	portconfundkik-0re	SLIDING GATE CONDOR	p09482	2	2 v 8

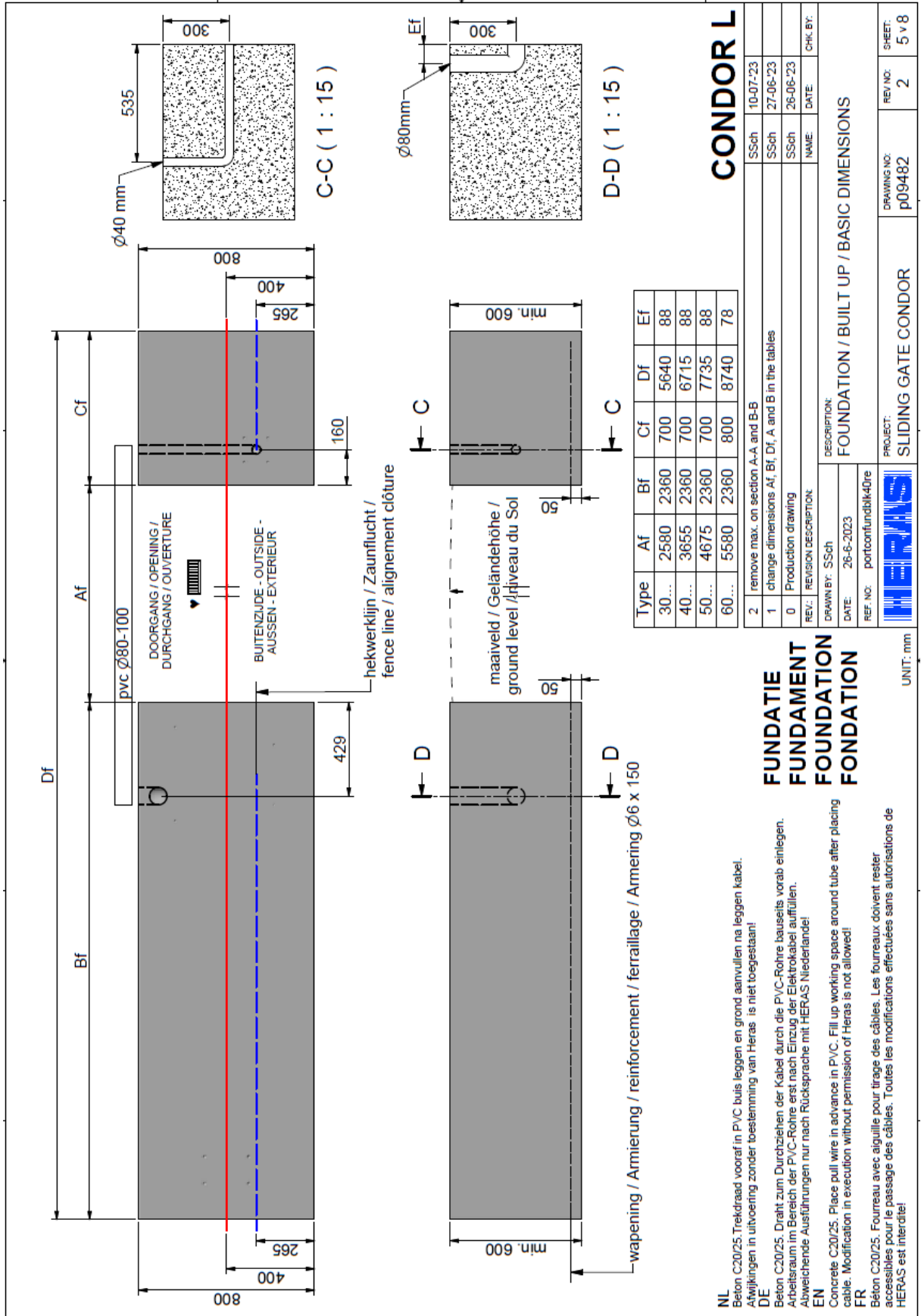

NL Beton C20/25. Trekdraad vooraf in PVC buis leggen en grond aanvullen na leggen kabel. Afwijkingen in uitvoering zonder toestemming van Heras is niet toegestaan!

DE Beton C20/25. Draht zum Durchziehen der Kabel durch die PVC-Röhre bauseits vorab einlegen. Arbeitsraum im Bereich der PVC-Röhre erst nach Einzug der Elektrokabel auffüllen. Abweichende Ausführungen nur nach Rücksprache mit HERAS Niederlande!

EN Concrete C20/25. Place pull wire in advance in PVC. Fill up working space around tube after placing cable. Modification in execution without permission of Heras is not allowed!

FR Béton C20/25. Fourreau avec aiguille pour tirage des câbles. Les fourreaux doivent rester accessibles pour le passage des câbles. Toutes les modifications effectuées sans autorisations de HERAS est interdite!

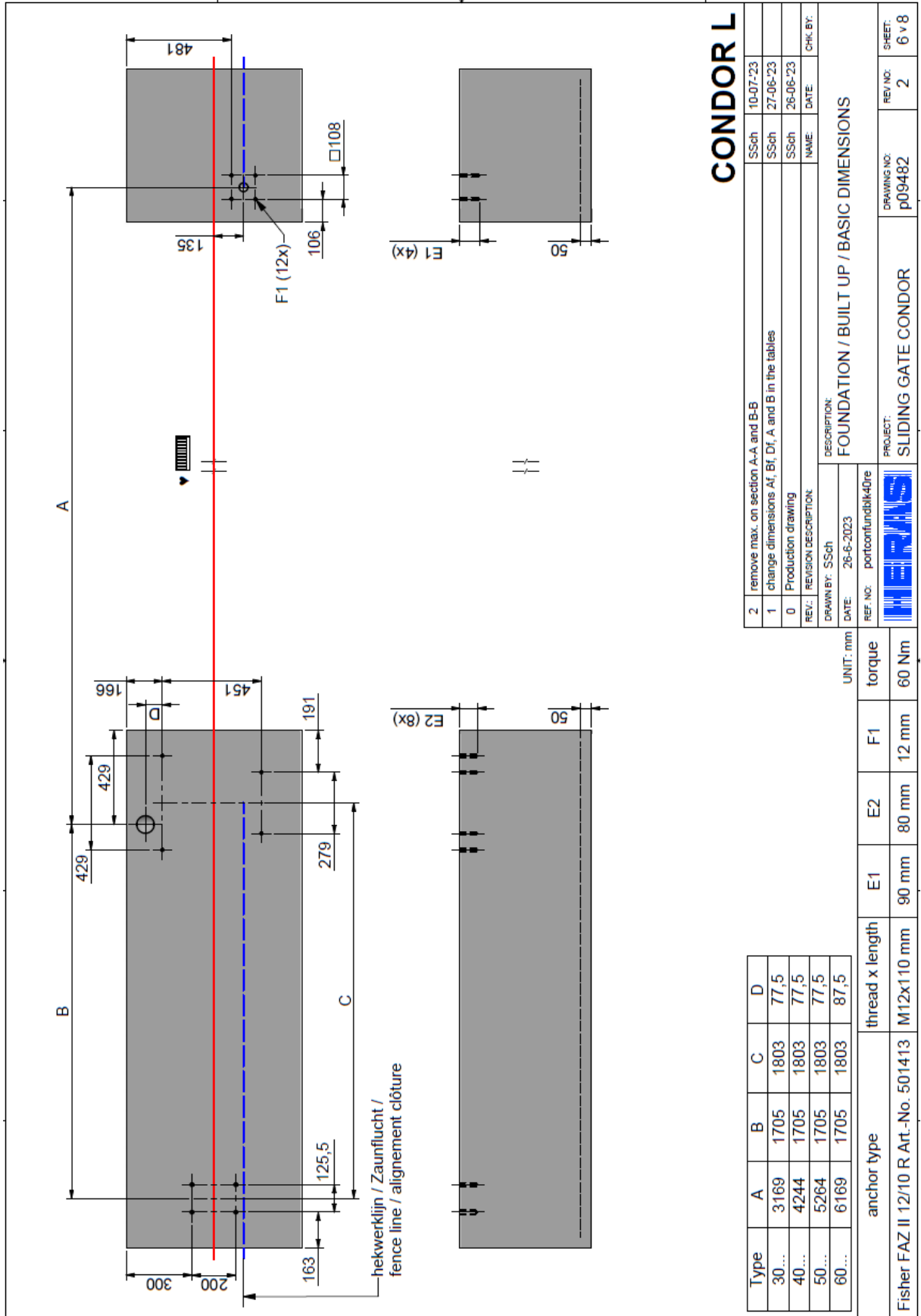

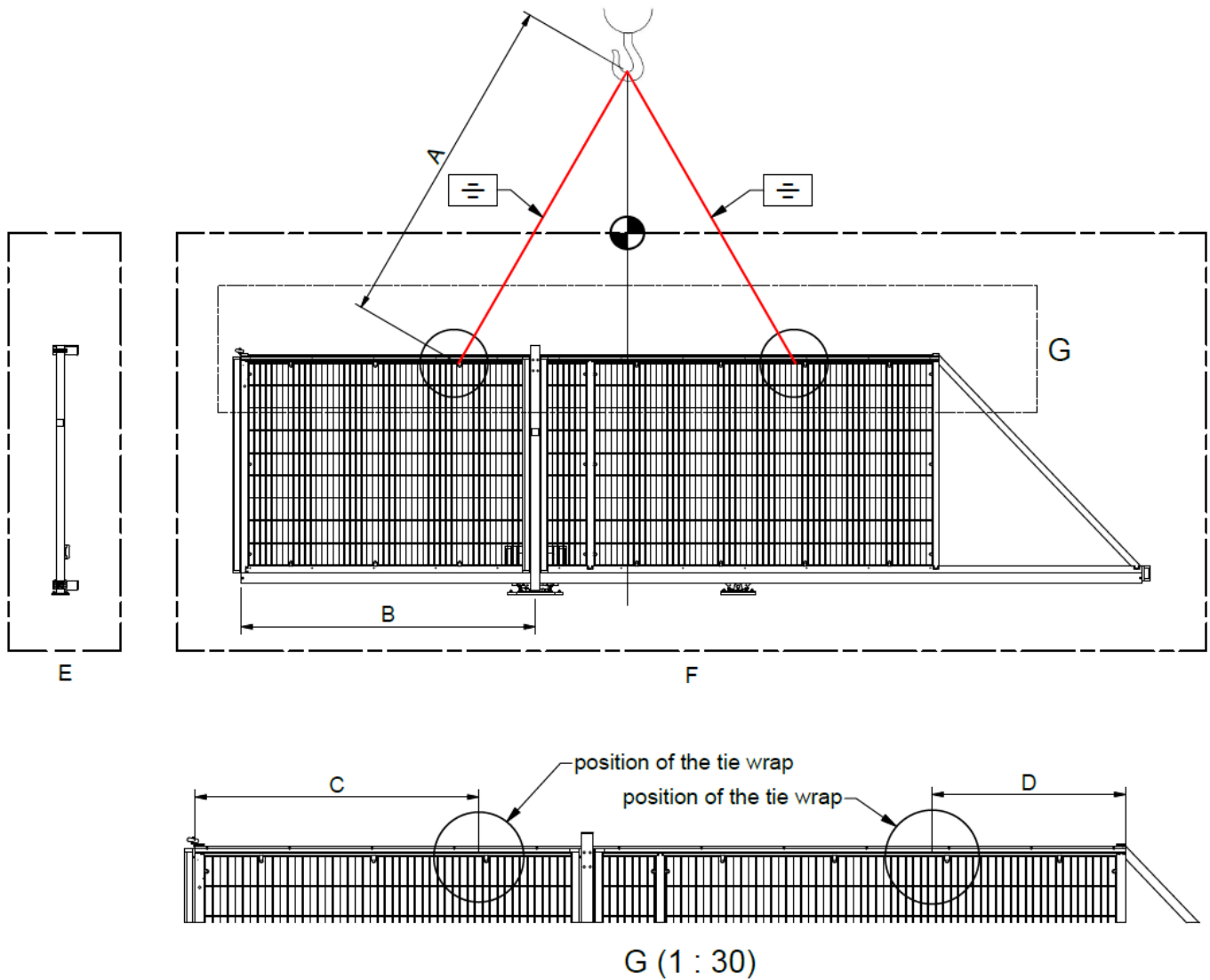

sliding gate type	A [mm]	B [mm]	C [mm]	D [mm]	E [kg]	F [kg]
30...	2000	904	845	291	23	210 - 245
40...	3000	1471	912	299	23	270 - 280
50...	3000	1997	1437	774	23	295 - 310
60...	3000	2654	2094	1117	23	405 - 420

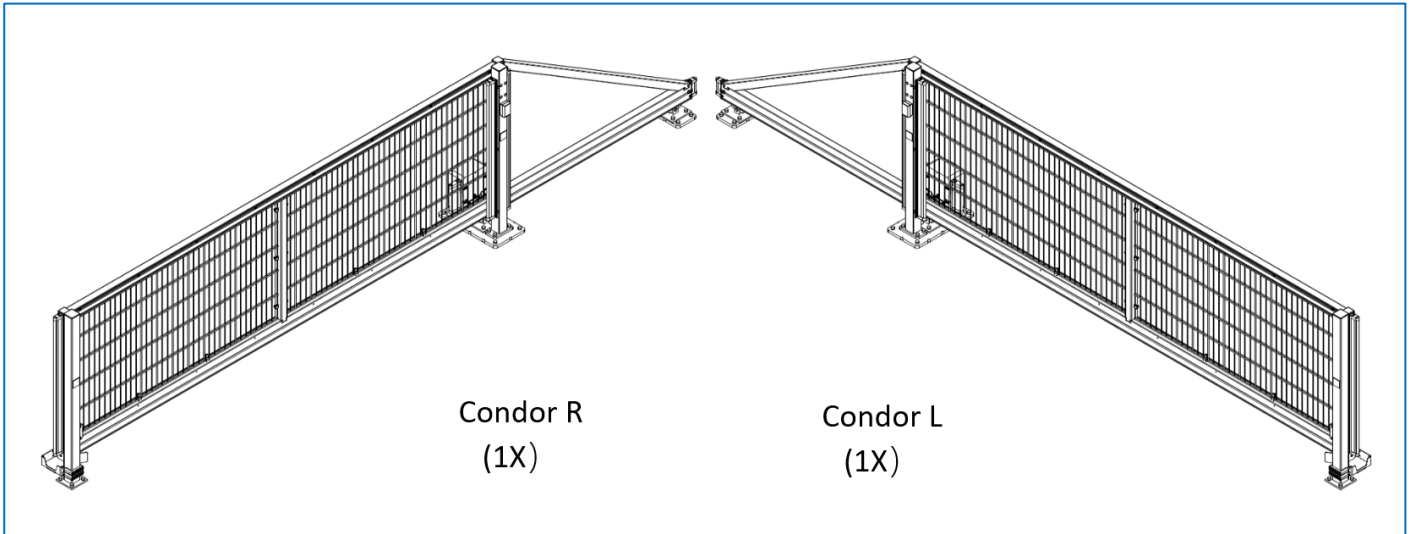

**NB: Anchor sets are included**



(12X)

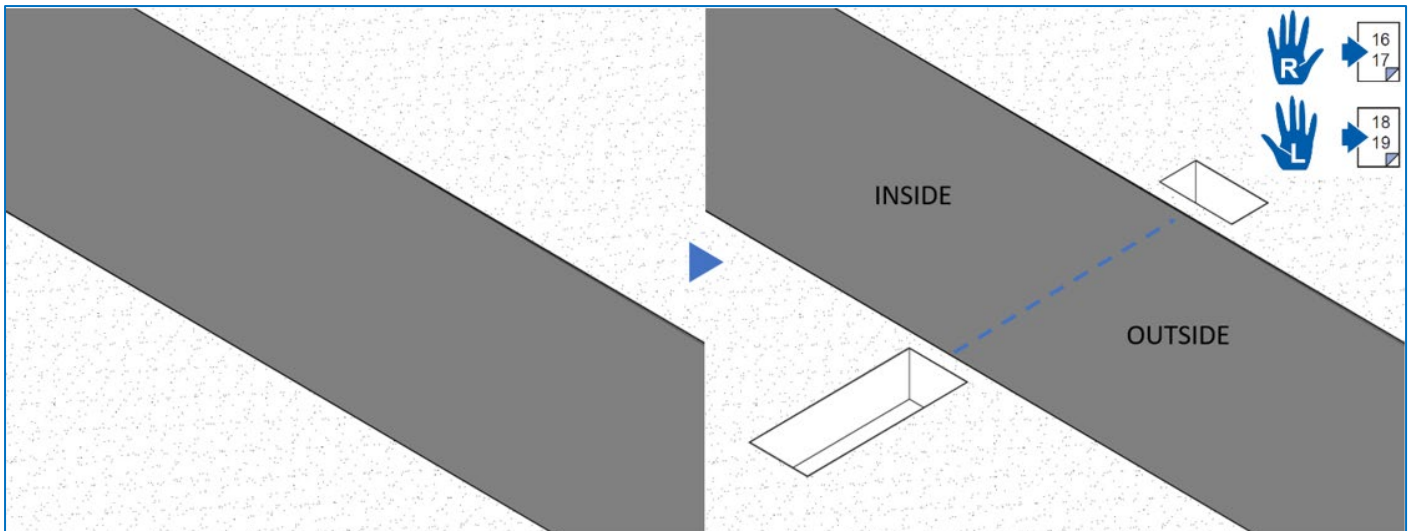

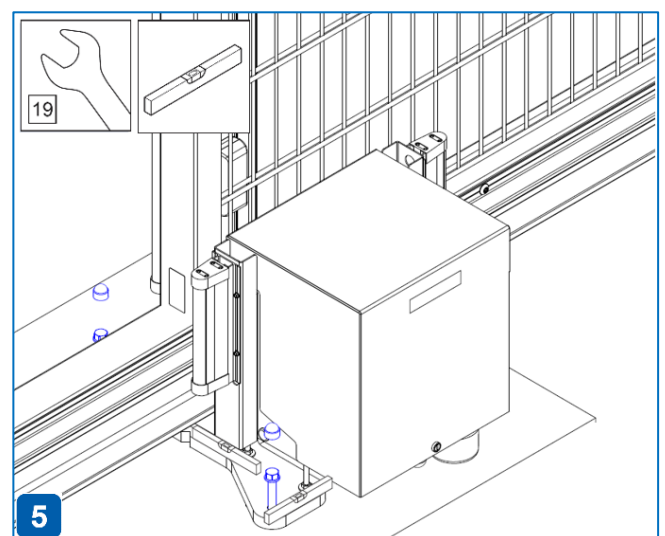
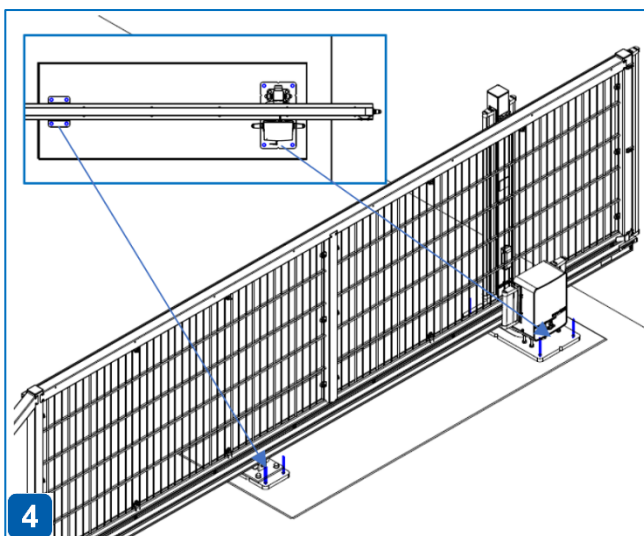
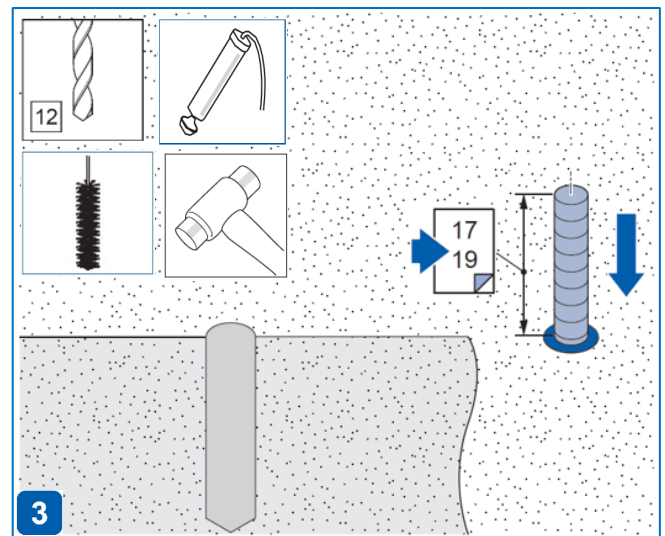
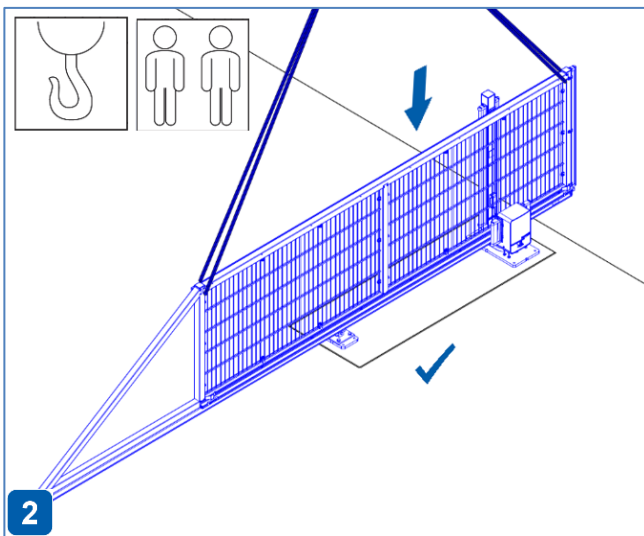
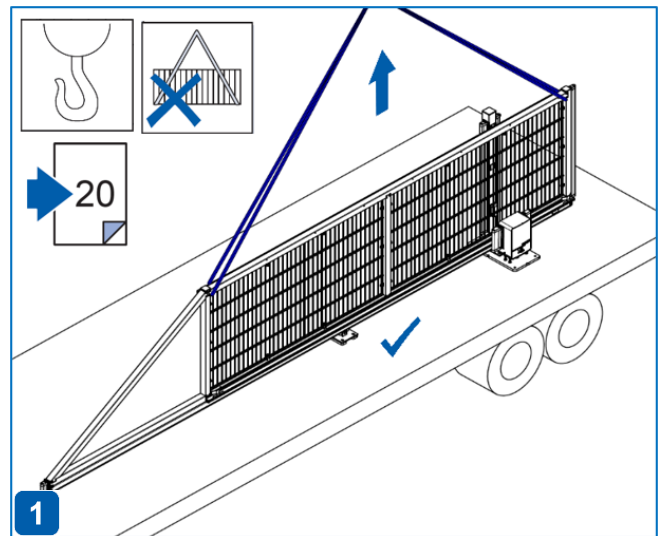
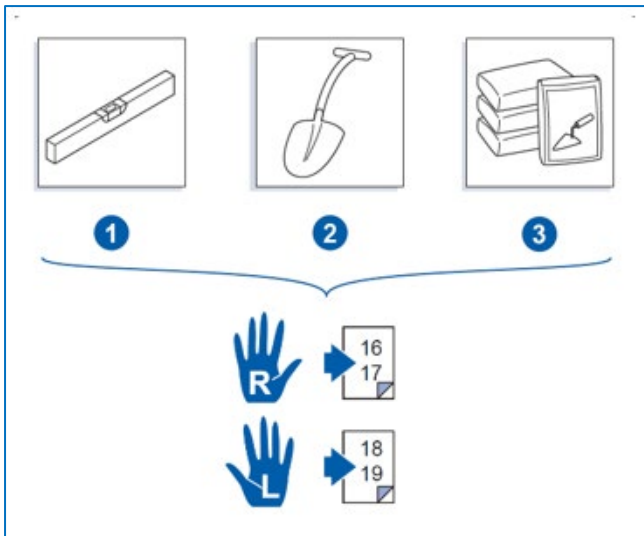

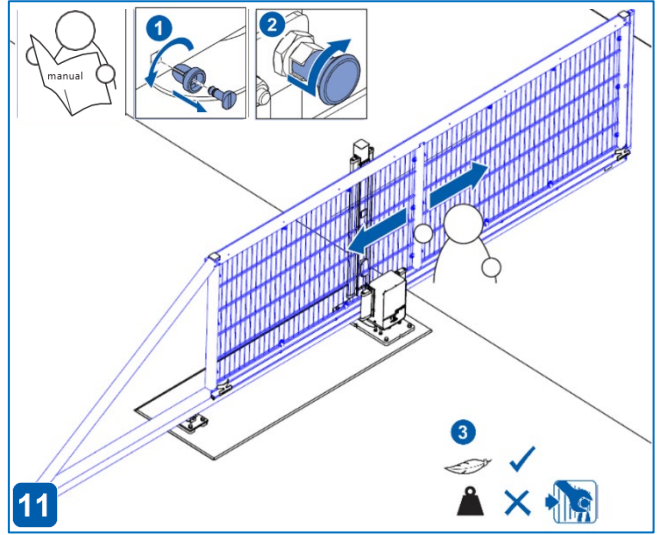
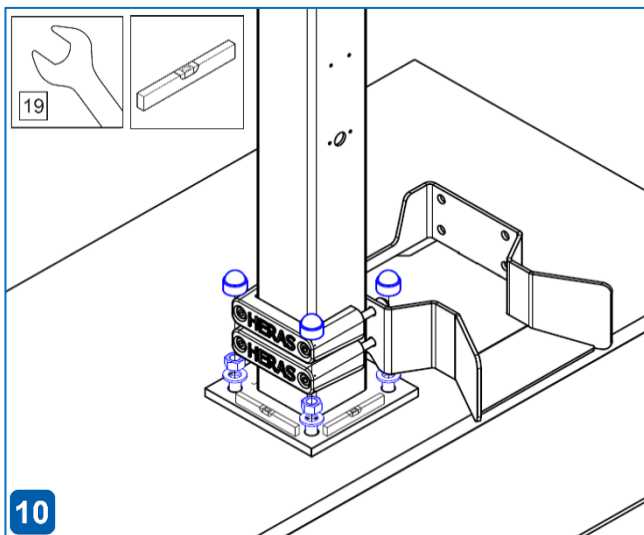
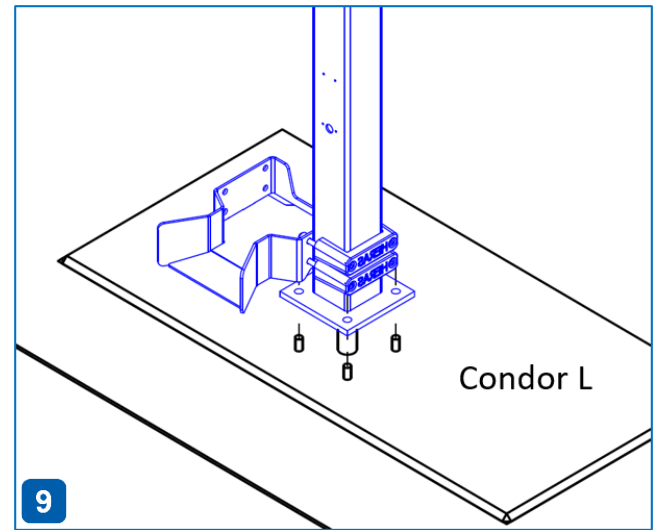
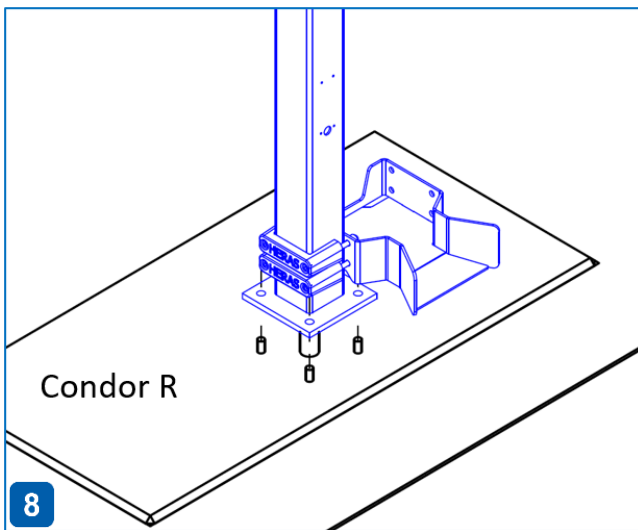
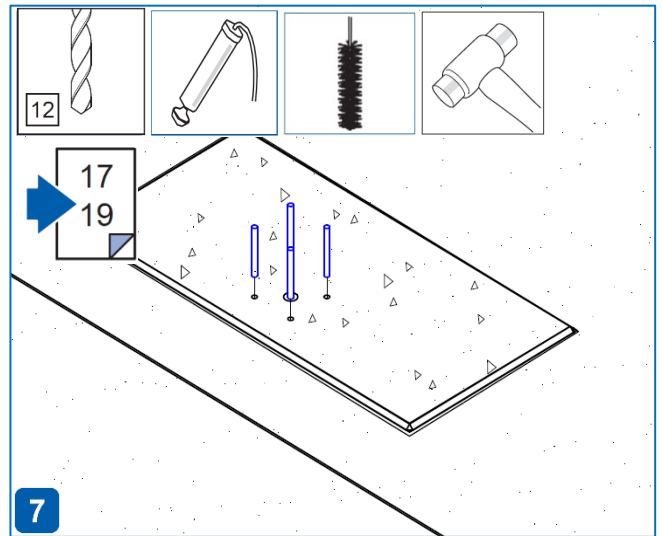
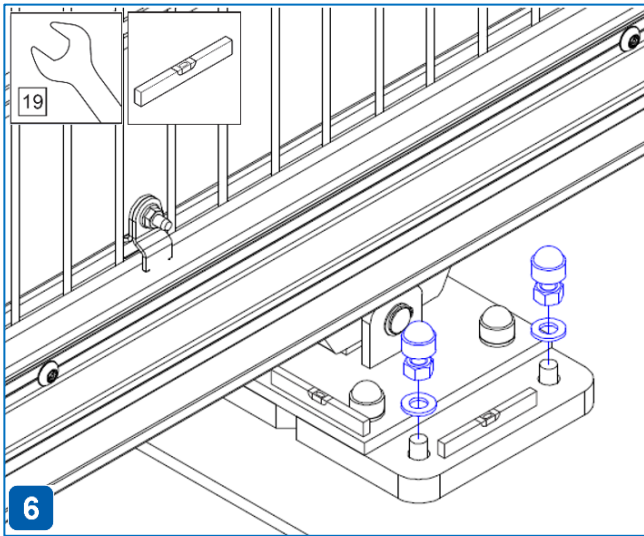

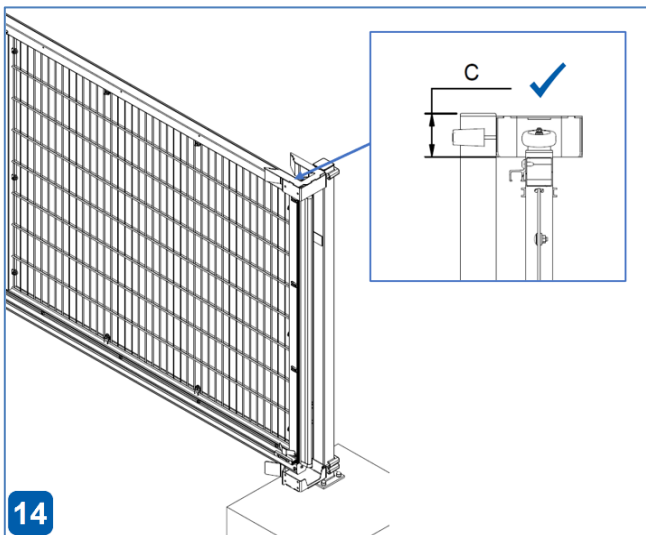
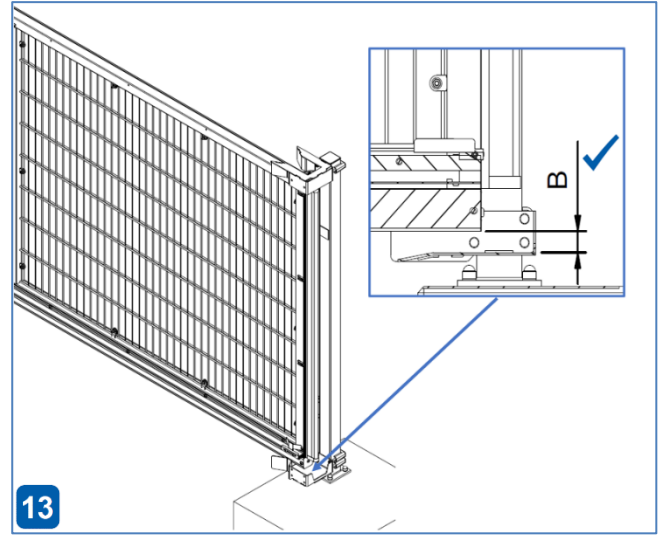
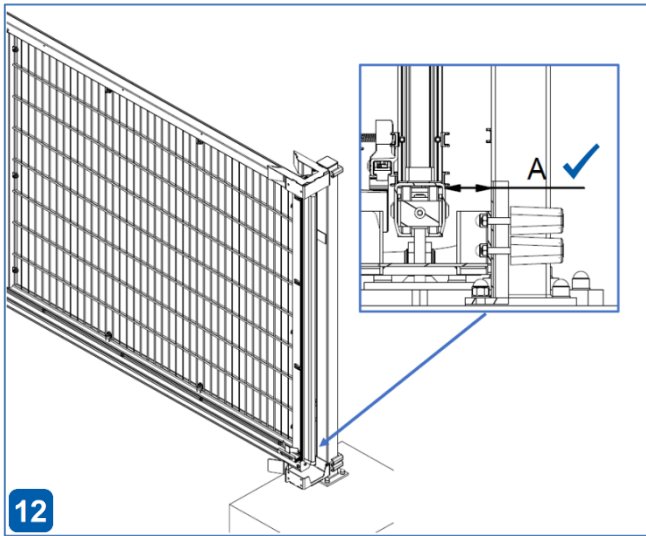

Type	A (in mm)	B (in mm)	C (in mm)
30...	$62 \pm 3$	$30 \pm 5$	$92 \pm 3$
40...	$62 \pm 3$	$30 \pm 5$	$92 \pm 3$
50...	$62 \pm 3$	$30 \pm 5$	$92 \pm 3$
60...	$46 \pm 3$	$30 \pm 5$	$92 \pm 3$

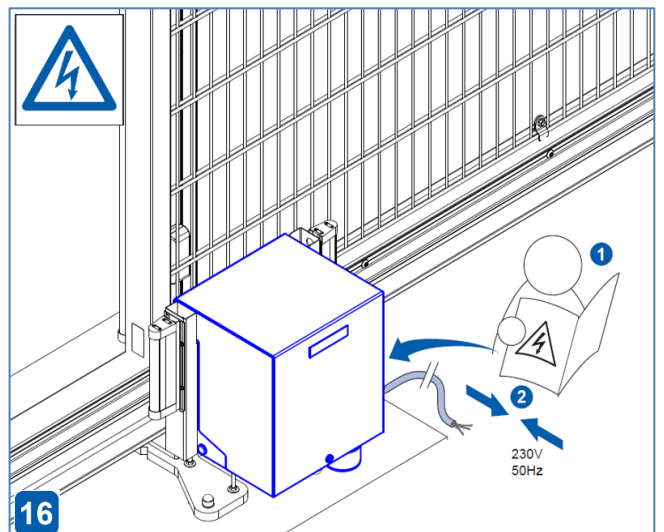
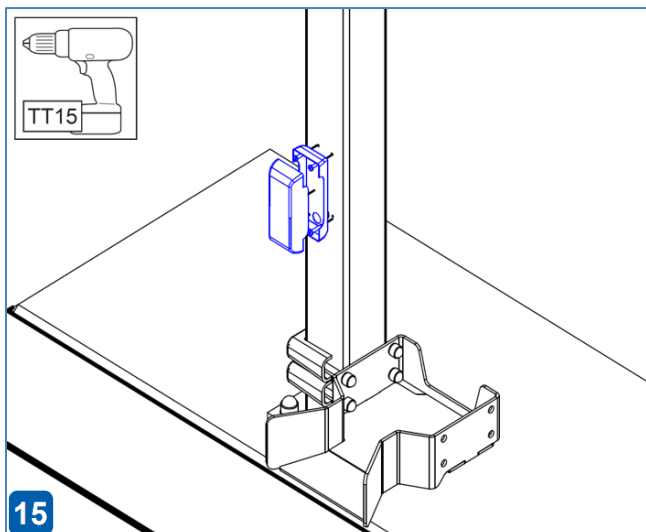



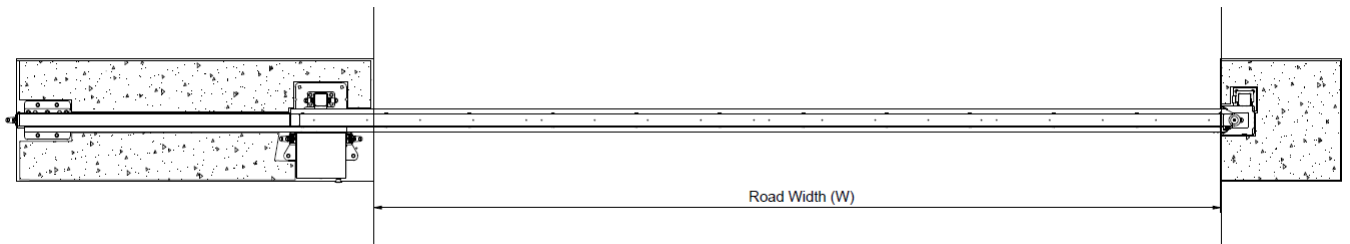

Situation 1: Gate Type Size = Road width (W) ✓

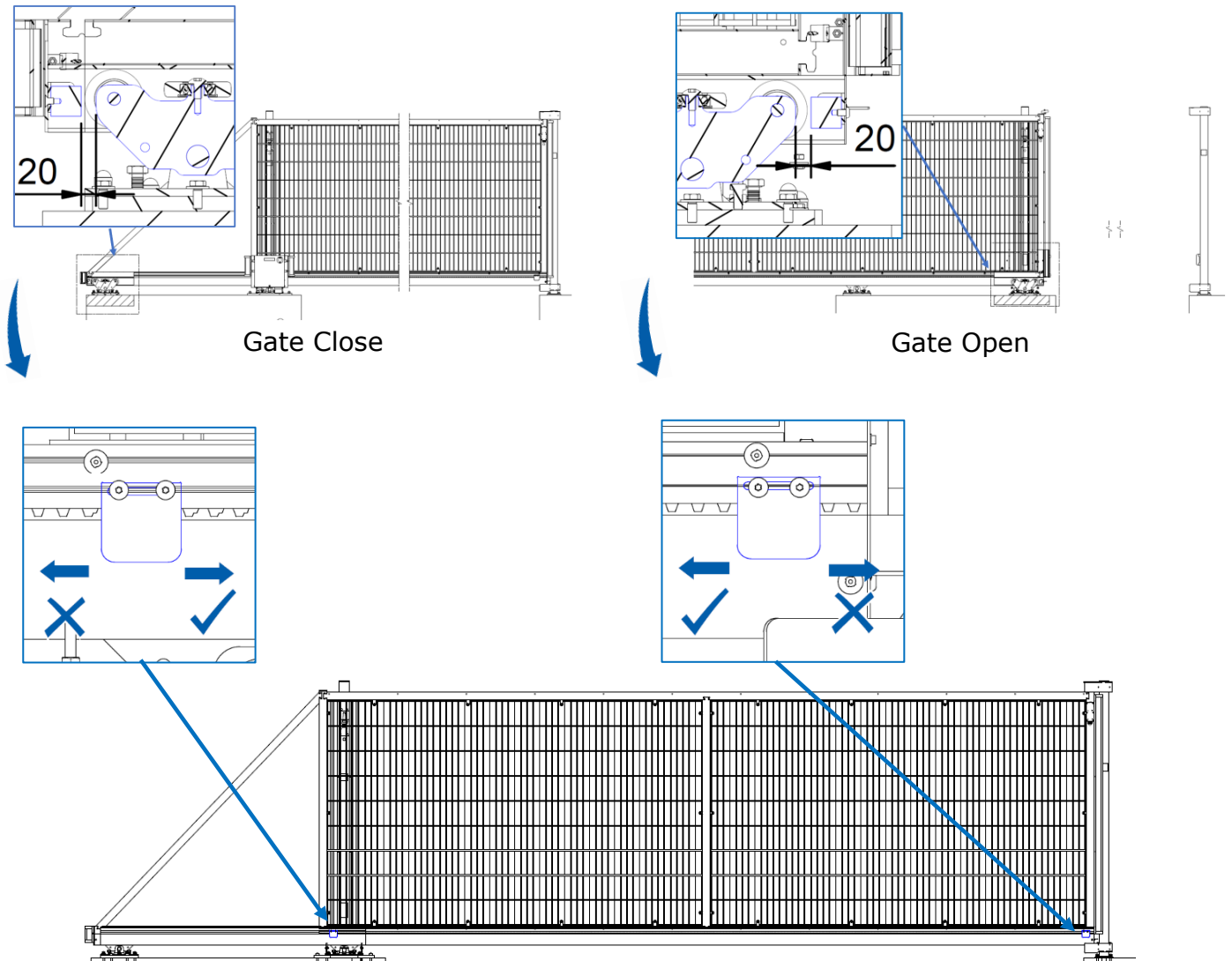

Situation 2: Gate Type Size > Road width (W)



user manual HMDLP\_Basic\_Condor\_v2.2

Please read the user manual before using the gate for the first time. The user manual is available on the website [www.heras.com](http://www.heras.com) or on the CD-ROM provided with the gate.

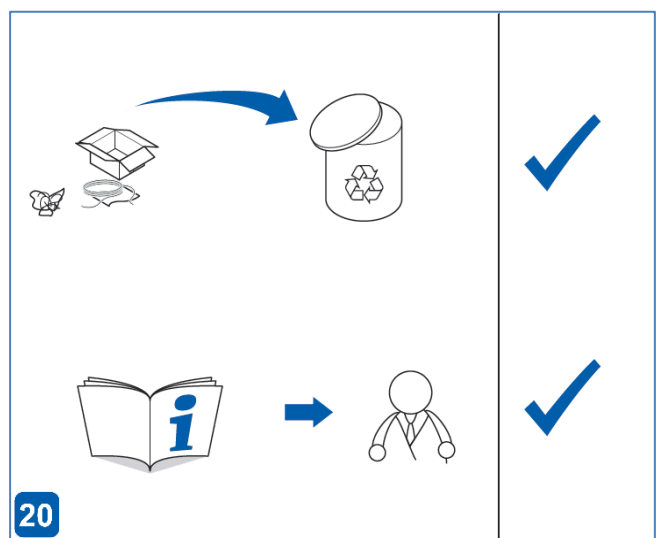
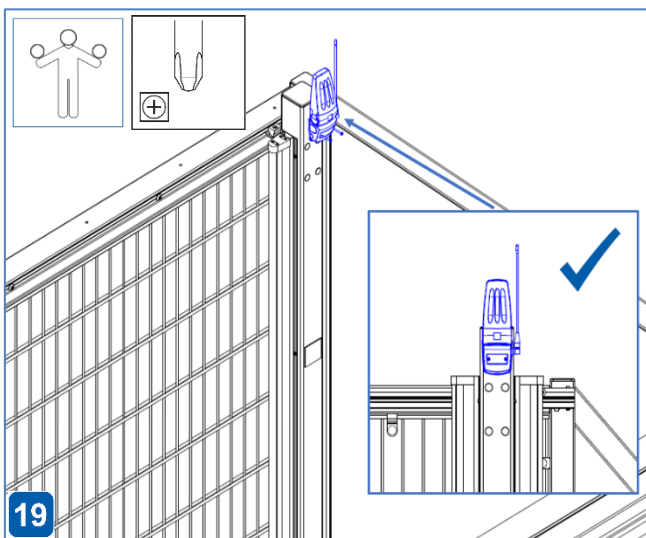
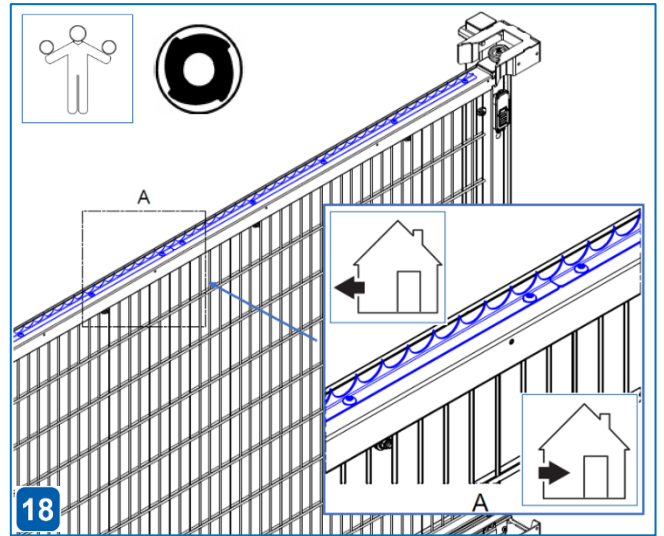
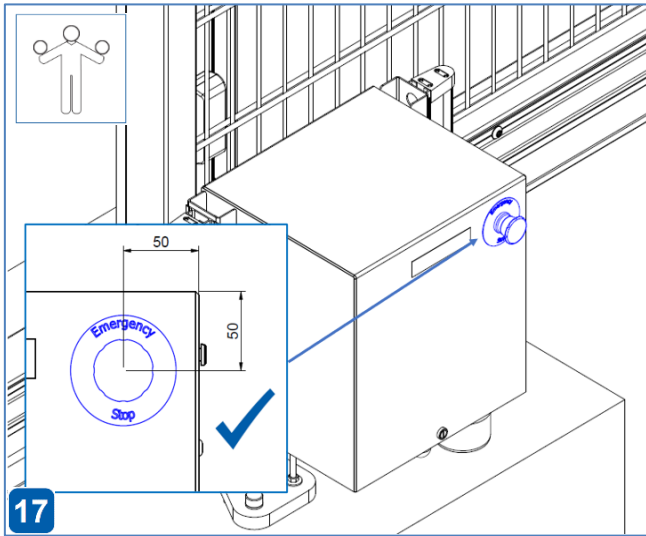





---

<b>The Netherlands</b>	<b>Tel: +31 (0) 882 740 274</b>	<b>info@heras.nl</b>
<b>Germany</b>	<b>Tel: +49 (0) 2872 94980</b>	<b>info@heras.de</b>
<b>France</b>	<b>Tel: +33 (0) 3 88 067 000</b>	<b>contact@heras.fr</b>
<b>United Kingdom</b>	<b>Tel: +44 (0) 808 164 2250</b>	<b>info@heras.co.uk</b>
<b>Sweden</b>	<b>Tel: +46 (0) 77 1506050</b>	<b>info@heras.se</b>
<b>Norway</b>	<b>Tel: +47 (-) 22 900 555</b>	<b>post@heras.com</b>
<b>Denmark</b>	<b>Tel: +45 (0) 7586 8296</b>	<b>info@herasdanmark.dk</b>
<b>Export</b>	<b>Tel: +31 (0) 499 551 523</b>	<b>export@heras.com</b>

---

Local supplier stamp / Lokal återförsäljare, stämpel